

- General Purpose Piezoelectric Triaxial Accelerometer
- Shear design
- Piezoelectric ceramic PZT-5
- Sensitivity – 10pC/g
- Mass – 25grams
- 3 x 10-32UNF connectors
- Use with a Low noise cable

The GCT10-TH is a general purpose Triaxial piezoelectric accelerometer with three side entry 10/32UNF microdot connectors.

The accelerometer has a single through hole for mounting via studs. Featuring a shear design PZT-5 sensing element the GCT10-TH provides high accuracy up to 7kHz

Specification	Metric	Imperial
Sensitivity	1.02pC/(m/s ²)	10pC/g
Measurement Range (pk)	±9800m/s ²	±1000g
Frequency Range ±10%	7000 Hz	
Resonant Frequency	≥15 kHz	
Non-Linearity	≤1 %	
Transverse Sensitivity	≤5 %	
Overload Limit (Shock)	±29400(m/s ²)pk	±3000gpk
Operating Temp. Range	-55 to +150°C	-65 to +302°F
Polarity ↑	Positive	
Capacitance	960 pF	
Size (excluding connector)	25.4 x 25.4 x14 mm	1"x 1" x0.55"
Weight	25gm	0.88oz
Sensing Geometry	Shear	
Sensing Element Material	PZT-5	
Case Material	Titanium	
Connector Position	Side	
Case sealing	Welded	
Electrical Connection Type	3 x 10-32UNF Microdot	
Mounting	1 x Ø5mm through hole	

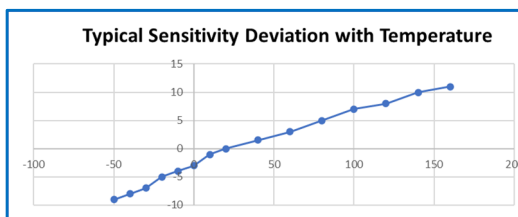
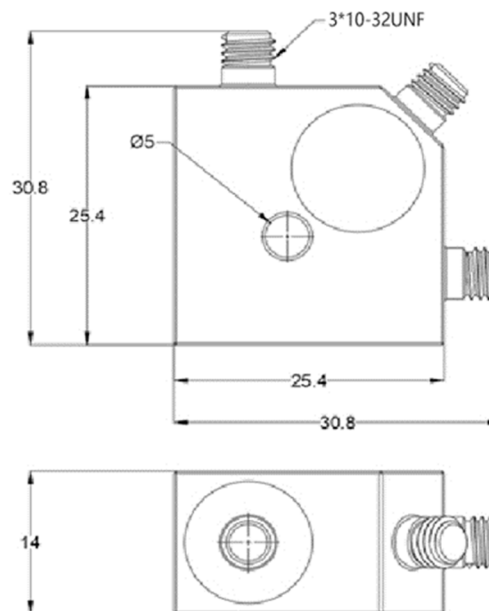

It is recommended that the GCT10-TH is used with a low noise cable from Kemo's range to reduce triboelectric noise.

- 1A2-30 – 3m(10ft) 10/32UNF microdot to BNC plug
- 1A2-50 – 5m(15ft) 10/32UNF microdot to BNC plug
- 1A1-30 – 3m(10ft) 10/32UNFmdot to 10/32UNFmdot
- 1A1-50 – 5m(15ft) 10/32UNFmdot to 10/32UNFmdot